

NPE2024 Show Rules & Regulations

Table of Contents

- **Mandatory participation for Exhibitors requiring drayage – NPE Bundle Package pricing Rule 22.**
- **Exhibitors displaying hanging signs are requested to pay particular attention to Rule 31.**
- **Exhibitors displaying operating machinery are requested to pay particular attention to Rules 38 and 50.**
- **Those companies that may require anchoring of machinery (Rule 7) at NPE2024 MUST contact Show Management to review anchoring requirements and the Orange County Convention Center (OCCC) policy.**

QUESTIONS:

NPE2024 Exhibitor Services: exhibit@npe.org

Rules & Regulations

- | | |
|---|--|
| 1. Terms & Conditions | 33. Indemnification |
| 2. Principal Purpose | 34. Installation & Dismantle Labor |
| 3. Amendment to Rules | 35. Insurance |
| 4. Admission to Exhibit Floor & Exhibit Hours | 36. International Shipments |
| 5. Aisles | 37. Limitation of Liability |
| 6. Americans with Disabilities Act | 38. Machinery, Robots, & Equipment Placement |
| 7. Anchoring Machinery | 39. Meeting Rooms at Orange County Convention Center (OCCC) |
| 8. Balloons, Air Devices & Drones | 40. Move-Out Material Removal from Premises |
| 9. Booth Events, Games & Contests | 41. Music, Video, Photo & Copyrights |
| 10. Booth Personnel | 42. Noise Levels |
| 11. Cancellation of Company Participation & Space Changes | 43. NPE2024 Logos |
| 12. Cancellation of Show | 44. Odors |
| 13. Catering: Booth & Meeting Space | 45. Outdoor Exhibit Space |
| 14. Columns | 46. Plastics Industry Association (PLASTICS) Member Benefits for NPE2024 |
| 15. Compliance | 47. Reduction of Space |
| 16. Copyright, Patent & Trademark Infringements | 48. Rejected Displays |
| 17. Crate Storage | 49. Relocation of Booth |
| 18. Damage to Property | 50. Safety: Machinery, Robot & Exhibit |
| 19. Decoration | 51. Signs |
| 20. Default in Payment | 52. Solicitation, Costumes & Promotion |
| 21. Divisions/Subsidiaries | 53. Storage |
| 22. Drayage | 54. Subleasing |
| 23. Electrical Safety | 55. Target Dates |
| 24. Eligible Exhibits | 56. Trusses |
| 25. Exhibitor Appointed Contractors (EAC) | 57. Unoccupied Space |
| 26. Fire Hose Cabinets, Alarms & Exits | 58. Utility Package Pricing |
| 27. Floor Load Capacity | 59. Vehicle Displays |
| 28. Food & Beverages | 60. Videotaping & Photography |
| 29. Food Distribution | 61. Walls & Backgrounds |
| 30. Handouts & Give-A-Ways | 62. Guidelines for Display & Column Specifications |
| 31. Hanging: Displays, Signs, Banners & Trusses | |
| 32. Hazardous & Prohibited Material | |

1. Terms & Conditions

Exhibitors understand and agree that these show rules and regulations (“Rules”) are an integral and binding part of the exhibit space contract (“Contract”). Exhibitors, on behalf of itself and its employees, agree to abide by all Rules, including those previously issued and any updates and/or correspondence outlining revised and new policies. Abiding by the Rules will lead to a successful experience for all.

“Booth Personnel” refers to those employees of an Exhibitor who are assigned to work at Exhibitor’s booth during the “Exposition,” “Show,” “Event” and “NPE2024” (in each case whether capitalized or not) refer to as the context requires.

“OCCC” refers to the Orange County Convention Center, the owner of the facility in which the exposition is located.

2. Principal Purpose

NPE2024: The Plastics Show is produced by and is the property of the Plastics Industry Association (herein referred to as PLASTICS) and the word Management and phrase Show Management refers in either case to PLASTICS, its directors, officers, committees, agents, or employees acting for PLASTICS in management of the show. The principal purpose of the show is to stimulate interest in and demand for plastics-industry-related products and services in general, herein referred to as “Principal Purpose.” No Company shall engage in any activity inconsistent with this Principal Purpose, including, but not limited to interference with and/or disturbance and/or damage to another exhibitor’s display, technology, networking, or promotional/sponsorship opportunities. Company shall cease any activity determined to be inconsistent with the Principal Purpose immediately upon notification by Management to do so. Management, at its discretion, may take any action it deems appropriate (including, but not limited to issuing written warnings, removal of Company from NPE2024, expulsion from any future show(s), and/or suspension or elimination of NPE show history points) against a Company for conduct detrimental to NPE2024.

3. Amendment to Rules

Any matters not specifically covered by these Rules may be amended at any time by Show Management and all amendments so made shall be binding on Exhibitor equally with the stated Rules.

4. Admission to Exhibit Floor & Exhibit Hours

No person **under the age of 16** will be admitted in the exhibit halls during the installation and dismantling periods. All persons on the exhibit floor must have proper registration credentials.

Students 14-16 years of age will be permitted in the exhibit halls during show hours under the supervision of an adult with proper credentials.

Show Management reserves the right to host student groups of any age on the show floor with appropriate supervision and guidance during show hours. No individual exceptions will be made.

Booth Personnel will be permitted to enter the exhibit hall up to two hours before the scheduled opening time each day of the show.

Booth Personnel will be permitted to remain in the exhibit hall two hours after show closing. Exceptions must be requested in writing by submitting the **Booth Events & Hall Access Request Form** available on the Exhibitor Dashboard. **Deadline: April 8, 2024**

Booth visitors will not be permitted to enter the exposition during non-show hours unless invited by Exhibitor to a booth event pre-approved by Show Management ([Rule 9, Booth Events, Games & Contests](#)).

Each Exhibitor is required to keep at least one Booth Personnel in its booth during all show hours, failure to comply will be subject to removal of its exhibit from the show at Exhibitor’s expense.

Exhibitors are not permitted to dismantle or remove their display prior to 3:00pm on the last day of the show without written permission from Show Management.

The official exposition schedule is as follows:

Monday, May 6, 9:00am – 5:00pm

Tuesday, May 7, 9:00am – 5:00pm

Wednesday, May 8, 9:00am – 5:00pm

Thursday, May 9, 9:00am – 5:00pm

Friday, May 10, 9:00am – 3:00pm

5. Aisles

All aisle space belongs to PLASTICS. Obstruction of aisles or booths is not permitted. No exhibit or advertising will be allowed to extend beyond the booth space assigned to the Exhibitor. All demonstration equipment to include machinery, machine **monitors/screens (HMI's)**, keypads, rotating extensions, demonstration, and operators' position must be located inside the rented booth space 1' / .304M from the aisle line. **TV monitors are exempt from the 1' / .304M set back rule.**

Exhibitors with live shows or any other activity meant to draw attendees must occupy exhibit space to accommodate not only the show but also the audience. Furthermore, the stage for the show, or central floor plan for the booth activity must be located inside the booth and directed to an audience inside the booth not to an audience that would congregate in the aisles or in neighboring booths. If any activity impedes the flow of traffic in the aisles, the show or activity will be terminated immediately by Show Management and/or the OCCC Fire Marshal. No warning will be issued to re-position the stage or activity to accommodate an audience.

To expedite the movement of freight in and out of the exhibit halls, certain aisles have been designated as **no freight aisles**. Exhibitors are not permitted to place any freight or display materials in the aisles during installation or dismantling periods of the show. The aisles must be kept clear for the specific use of material handling trucks and equipment. Visit www.npe.org/exhibit, click on **View Live Floor Plans** to review designated no freight aisles.

6. Americans with Disabilities Act

Exhibitors are advised of their obligations related to the Americans with Disabilities Act (ADA) Title III. The ADA requires that the Exhibitor's display must be accessible to persons with disabilities, and Exhibitor acknowledges that it is solely responsible for assuring its display complies with the ADA.

Exhibitor hereby warrants that it will provide auxiliary aids and services to individuals with disabilities suitable for effective communications between all parties in accordance with requirements of the ADA. Exhibitor further agrees to indemnify and hold PLASTICS harmless for any claims arising out of or in connection with the Exhibitor's failure to comply with the ADA.

7. Anchoring Machinery

Some exhibits require anchoring to set-up operating machinery demonstrations. Anchoring is allowed but **MUST** follow the OCCC facility specifications and guidelines.

4 holes / points – Available in West Exhibit Halls B-E & Entire South Hall. NOTE: There is NO anchoring in Exhibit Hall A.

- **OCCC staff must do all in *booth anchoring / drilling*. The exhibitor must submit a copy of their floor plan a minimum of *60 days prior to move-in*.**

8. Balloons, Air Devices & Drones

Any Exhibitor intending to utilize balloons, air devices and/or drones are required to obtain approval from Show Management and OCCC. All Exhibitor promotional activities, balloons, air devices and/or drones must remain within the confines of Exhibitor's own booth. The use of Drones, or other airborne recording devices will **NOT** be permitted during show hours. Exhibitors must complete and submit the OCCC NPE2024 Balloons and Other Lighter-Than-Air Objects Agreement for approval by **April 2, 2024**.

9. Booth Events, Games & Contests

Exhibitor must submit the Booth Events & Hall Access Request Form to Show Management for approval by **April 8, 2024**, for any events, including, but not limited to shows, presentations, hospitality, press conferences, contests, operation of games of chance or lottery devices, and/or the actual or simulated pursuit of any recreational pastime to be held within its booth.

If an event is scheduled to be held before or after Show operating hours, Exhibitor must retain booth security guards for the event and is responsible for escorting invited guests directly to/from the show entrance and the Exhibitor's booth. Exhibitor Booth Personnel and invited guests must remain in Exhibitor's booth during the event. No admission will be permitted to the show floor more than two hours prior to the show operating hours, and the show floor must be cleared two hours following the show operating hours. Exhibitor is responsible for all clean up necessary (vacuuming and trash removal) at the end of each event.

Any activity deemed by Show Management, in its sole discretion, to be objectionable, unsafe, or disruptive to neighboring exhibitors or attendees is prohibited and will be halted immediately upon the request of Show Management.

Distribution of any materials or performing of any other solicitations in the aisles or public areas is prohibited. Show Management, at its discretion, may take any action it deems appropriate (including, but not limited to **issuing written warnings**, expulsion from the show and/or suspension or elimination of NPE show history points) against an exhibitor for conduct detrimental to the show.

10. Booth Personnel

Exhibitor's Booth Personnel shall be Exhibitor's employees who are staffing the Exhibitor's booth. Booth Personnel must maintain a professional appearance. All Staff hired for the event (defined as any Booth personnel who are not a full-time employee of the exhibiting company) must wear business professional attire. Show Management considers as inappropriate, apparel and/or costumes that are not normally worn by business professionals in offices or factories. Booth Personnel are not permitted to promote the exhibiting company outside the contracted exhibit space. This rule applies to company personnel and any exhibit personnel hired for the show period. Show Management reserves the right to remove said individuals. Exhibitor employees not acting as Booth Personnel during the show must register as attendees.

11. Cancellation of Company Participation & Space Changes

Both PLASTICS and Company acknowledge that in the event of Company's cancellation of participation, PLASTICS will sustain substantial monetary losses that cannot precisely be determined. If Company cancels its participation in the NPE2024 Space Draw by Friday, February 24, 2023, at 5:00 PM Eastern Time, NPE2024 deposits paid are refundable, NPE2021 credits applied are non-refundable. Due to the difficulty of determining and detailing said losses for cancellation after the February 24, 2023, deadline, Company agrees to pay exhibit space fees in accordance with the following schedule if Company cancels participation in the show and/or fails to occupy the exhibit space contracted/assigned:

- a) If Company cancels its participation February 25, 2023, through March 31, 2023, Company shall be obligated to pay 20% of its total exhibit space fees; NPE2021 credits applied are non-refundable.
- b) If Company cancels its participation April 1, 2023, through June 30, 2023, Company shall be obligated to pay 50% of its total exhibit space fees; NPE2021 credits applied are non-refundable.
- c) If Company cancels its participation July 1, 2023, through May 11, 2024, Company shall be obligated to pay the entirety of its total exhibit space fees; NPE2021 credits applied are non-refundable.

Notwithstanding anything herein to the contrary, in the event Company cancels its exhibit participation in the show and subsequently purchases exhibit space through a PLASTICS authorized agent, such Company will remain liable to PLASTICS for all deposits and payments due for contracted exhibit space assigned to the Company's PLASTICS/NPE2024 Contract, in addition to any deposits and payments Company is contracted for to the PLASTICS' authorized agent.

To be effective, all Company cancellations of participation in the show must be received by Management in writing (return receipt requested). The date of cancellation shall be the date Management received the written cancellation. All cancellation fee(s) are payable immediately upon cancellation. The cancellation fee(s) terms shall apply regardless of the execution date of this Contract. In such event, and without further notice to Company, Management shall have the right to use the space cancelled/defaulted by the Company to suit its own convenience, including assigning all or a portion of such space to another company. Management assumes no responsibility for inclusion of the cancelled/defaulted Company or descriptions of its products on www.npe.org, in the show directory, brochures, news releases, or other materials. Company remains liable for any and all balance payments due on the cancelled/defaulted space contracted/assigned.

Company has the option to change its assigned exhibit space by submitting a request for booth changes to Management and is required to relocate its space based on inventory available at the time the space is being changed. If Company is reducing its contracted/assigned exhibit space, the Company remains financially obligated for the amount set forth for the originally contracted/assigned space. If Company is increasing its contracted/assigned exhibit space, Company becomes financially obligated and contracted for the amount set forth for the reassigned exhibit space. If payments are not received by date(s) due, Management reserves the right to relocate the space contracted/assigned to the Company, and the Company remains financially obligated for the originally contracted/assigned space. Any company with an outstanding financial obligation to PLASTICS will not be eligible to exhibit at an NPE show until all past financial obligations are paid in full to PLASTICS.

12. Cancellation of Show

If the show is cancelled by Management in whole, as the result of riot, strike, civil disorder, act of war, act of nature, epidemic, pandemic, increased risk of harm or death from infectious disease, acts of terrorism, or any reason of any kind whatsoever not within Management's control, Company shall receive a return of, or relief from paying, 25% of its total exhibit space fees, and shall be obligated to pay 75% of its total exhibit space fees. The Company's NPE2021 credit would be applied as a payment towards the Company's 75% obligation. The parties understand that Company shall still owe 75% of its total exhibit space fees in this instance because space fees are paid in exchange for the services and costs associated with planning the show and with running the association in addition to the physical space itself. Therefore, if the show is cancelled under this clause, the parties understand that the non-refundable portion of its total exhibit space fees represent consideration for efforts and services already rendered. In all cases, NPE2021 credits applied are non-refundable. The term cancellation shall not include any change to the show for any cause identified above that results in a change to show dates, a reduction in the number of show dates, and/or a change in venue from Orlando to any other location.

13. Catering: Booth & Meeting Space

Exhibitors must utilize the services of the exclusive in-house caterer Centerplate, for in-booth and OCCC meeting space catering. Any food and/or beverage brought on to premises of the OCCC without written authorization from Centerplate are prohibited. (Refer to [Rule 28, Food & Beverages](#))

14. Columns

If a column containing fire hose cabinets, fire strobe light warnings, and/or fire alarm pull stations is located within an Exhibitor's booth, Exhibitor must always follow OCCC facility regulations and fire and safety regulations requiring that fire safety supports be visible and accessible. **To view columns with fire cabinet, fire strobe light warnings, and/or fire alarm pull stations:** Visit www.npe.org/exhibit, click on [View Live Floor Plans](#) to review designated columns.

15. Compliance

Exhibitor agrees and warrants as follows:

- A. The design, construction, transport, delivery, assembly, erection, installation (including placement and utility hook-ups) and condition of all machinery exhibited at the show by Exhibitor will at all times comply with all applicable national, state, and local laws and regulations; and,
- B. The operation, use, demonstration, adjustment, inspection, maintenance, servicing, setting up, modification, cleaning, unjamming, repairing, disassembly/breakdown and removal of the machinery, equipment, displays, and other materials exhibited at the Show by Exhibitor will, at all times, comply with all applicable national, state, and local laws and regulations.

The phrase "all applicable national, state, and local laws and regulations" includes, but is not limited to all laws and regulations relating to the provisions and maintenance of adequate safety devices and conditions for the installation and operation of machinery and equipment displays.

All machinery, equipment, displays, and other materials exhibited at the Show by the Exhibitor must be reasonably located and protected (e.g., by safety guards, fireproofing, and other fire safety measures) to prevent fire hazards and accidents (Refer to [Rule 50 Safety: Machinery, Robot & Exhibit](#) for more information). Adequate fencing and/or shielding of all operating machinery displays shall be installed to prevent attendees from coming into contact with the operating machinery and/or its movement by reaching over, under or around such protection. Show Management reserves the right, in its sole and absolute discretion, to reject, prohibit, or cease operation of any exhibit in whole or in part for non-compliance with what it deems to be safety requirements without prior notice to Exhibitor or without offering Exhibitor an opportunity to cure, and Exhibitor acknowledges and accepts such right.

16. Copyright, Patent & Trademark Infringements

Show Management's trademarks, logos, and service marks are and will remain the sole property of Show Management. Nothing in these show rules and regulations confers upon Exhibitor any right of ownership in Show Management's trademarks, logos, or service marks ("PLASTICS IP"). Exhibitor shall not use PLASTICS IP without the express written consent of Show Management. Exhibitor hereby grants Show Management a non-exclusive, non-transferable, and non-sublicensable license right to use its trademarks, logos, and service marks ("Company IP") subject to any restrictions specified in these show rules and regulations. Show Management shall not involve itself in any Exhibitor related patent infringements or trademark disputes before, during or after the Show related to Exhibitor's Company IP. Exhibitor should seek legal counsel to resolve any infringement issues. At any time, Company shall not involve itself in any PLASTICS IP related patent infringement or trademark disputes unless formally requested by PLASTICS in writing.

17. Crate Storage

Special care will be necessary in unpacking merchandise for display. Cardboard cartons will not be accepted for storage unless they are broken down flat and securely tied into bundles and properly tagged. Empty crates are required to be taken from the building as soon as possible. This will make it necessary to remove everything from the crate once it is opened and place an "empty" label (available from the Exhibitor Service Centers) on it immediately for removal. Be sure to remove all old labels first. No boards or skids will be accepted for storage unless securely tied into bundles and tagged. Materials not in accord with these regulations will be considered refuse and will be disposed of by the cleaners. It is suggested that small crates be nested into larger ones to reduce the number of pieces to be stored and thereby hasten their return during dismantling. To facilitate re-packing merchandise at the end of the show, some exhibitors have found it convenient to remove knocked down cartons to their cars and/or hotel rooms for ready access.

18. Damage to Property

Exhibitor is liable for any damage caused by it and/or its agents, including but not limited to Exhibitor Booth Personnel, to building floors, walls, or columns, or to standard booth equipment, or to other exhibitors' property. Exhibitor may not apply paint, lacquer, adhesive, or other coating to building columns, floors or to standard booth equipment. Exhibitor is responsible for damage to its uncrated or improperly packed shipments, concealed damage, for loss or theft of its material after delivery to its booth, or before material is picked up for return movement. It is expressly understood and agreed that Exhibitor will make no claim of any kind against Show Management and/or Freeman Companies, the general contractor, for any loss, damage, or destruction of goods, or for any damage of any nature to NPE2024 by reason of the failure to provide space for any exhibit and/or for the delivery or removal of the exhibit.

19. Decoration

To be consistent with the Principal Purpose and present a professional business environment, booth decoration must include floor covering and appropriate display. Show Management shall have full discretion and authority in the placing, arrangement, and appearance of all items displayed by Exhibitor. Show Management may require the replacing, rearrangement, or redecorating of any item or of any booth which Show Management deems inconsistent with the Principal Purpose or inappropriate for any other reason and no liability shall attach to Show Management for costs incurred by Exhibitor to comply with Principal Purpose.

20. Default in Payment

Any Exhibitor failing to pay exhibit space fees called for in the Contract on or before the due date(s) for such payment(s) shall be deemed to be in default and shall be deemed to have cancelled its participation in subject to the obligations ([Refer to Rule 11, Cancellation of Company Participation & Space Changes](#)).

21. Divisions/Subsidiaries

Divisions/subsidiaries of an Exhibitor may be eligible for representation in the Exhibitor's booth upon verification of eligibility and approval by Show Management. The fee for each division/subsidiary is USD \$1,000 and includes a listing in the online and printed show directories as a separate entity in the same booth location. Divisions/subsidiaries are defined as two or more companies that are legally related entities (i.e., parent company and subsidiary; subsidiaries of the same parent company; a corporation and division or a controlled company). If Exhibitor is a member of PLASTICS and receives NPE benefits, the Exhibitor's membership status must include and be associated with the divisions/subsidiaries represented in the booth or the divisions/subsidiaries must independently maintain a continuous membership in PLASTICS associated with the Exhibitor's membership. Application for division/subsidiary listings must be submitted online in the Exhibitor's profile update section of the exhibitor services website by **February 16, 2024**.

22. Drayage: The movement of show materials from shipping dock to booth for show set up and back to dock for return shipment at end of show.

PLASTICS and Freeman have worked diligently to create an inclusive package to assist exhibitors in projecting budgets and controlling expenses. Each exhibitor is required to order a booth package if the Exhibitor is bringing in drayage. If the Exhibitor is not bringing drayage into the show, the “NPE Bundle Package” does not apply.

“NPE Bundle Package” includes:

- Show Site material handling, machinery and display in/out.
- One-time Spotting/placement of machinery at the time of unloading from delivering carrier.
- Empty removal and storage.
- Nightly Vacuuming.
- Certified weight tickets must accompany all shipments.

(Refer to the Freeman – General Services Contractor section of the Exhibitor Dashboard.)

23. Electrical Safety

All wiring on displays or display fixtures must conform to the National Fire Protection Association NFPA 70 and Electrical Standard for Industrial Machinery or superseding standards and the Orlando Electrical Code. All display wiring must exhibit the seal, and/or such other seals of official approving agencies as may be required at the exposition complex. Wiring laid across floors shall be guarded by wood, metal, or other acceptable covers. All wiring for machines and displays must include one wire for ground.

24. Eligible Exhibits

Management has sole right to determine the eligibility of any Company or product for inclusion in the exposition. (Also see [Rule #2, Principal Purpose](#))

25. Exhibitor Appointed Contractors (EAC)

Exhibitors shall not contract for or use any services in connection with their exhibit while in the exhibit halls except those approved by Show Management prior to the show. The names of any persons or organizations other than those designated as official contractors who are proposed for the performance of any services for your booth at NPE2024 must be submitted to Show Management by **March 18, 2024**, for approval.

26. Fire Hose Cabinets, Alarms & Exits

Firefighting and emergency equipment may not be hidden or obstructed, including fire extinguishers, strobes, fire hose cabinets and standpipes. All emergency exits, hallways and aisles leading from the OCCC must be kept clear and unobstructed. Fire lanes must always be maintained on the loading docks (also see [Rule 14, Columns](#)).

27. Floor Load Capacity

The floor load capacity is 400 pounds per square foot in the South and North exhibit halls and 400 pounds per square foot in the West halls **except in a designated area within West Hall A. In this West Hall A designated area, the floor load is 300 pounds per square foot.** Visit www.npe.org/exhibit, click on [View Live Floor Plans](#) to review designated areas.

To determine the pounds per square foot criteria, divide the total weight of your machine, in pounds, by the square foot contact area of the machine on the exhibit floor. If the result is greater than the designated floor load capacity, please contact Show Management for review at exhibitorservices@npe.org.

Example:

Machine weight: 20,000lbs

Length of machine: 15'

Width of machine: 5'

Total contact area: 20,000 lbs. ÷ 75 sf. = 267 psf

Under no circumstances may the weight of any equipment or exhibit material exceed a hall’s maximum floor load capacity. Exhibitor accepts full and sole responsibility for any injury or damage to property or person resulting from failure, knowingly or otherwise, to distribute the load of their exhibit material in conformity with the maximum floor load specifications.

28. Food & Beverages

Catering and concessions are an exclusive service provided by the OCCC's Food Service Partner, Centerplate. Any food and/or non-alcoholic/alcoholic beverage brought on premises without written authorization from Centerplate are strictly prohibited. Sampling of food or non-alcoholic/alcoholic beverages offered by Exhibitors must be approved in writing in advance of the Show date by Centerplate and requires Exhibitor to be a distributor or manufacturer of the products to be sampled and such samples must be show related. Sampling portions for food is limited to three-ounce servings and non-alcoholic/alcoholic beverages are limited to four-ounce servings. Food or non-alcoholic/alcoholic beverages may not be sold by exhibitors.

29. Food Distribution

Exhibitors are not permitted to distribute popcorn or shelled peanuts from their booths. All food and/or beverages brought on premises must receive written authorization from the official OCCC Food Service Partner, Centerplate. [\(Refer to Rule 28, Food & Beverages\)](#)

30. Handouts & Give-A-Ways

Exhibitors may distribute promotional items such as samples, souvenirs, publications, sales literature, buttons, stickers, lapel pins, etc., but only within the confines of their own booth. The distribution of any articles that interfere with the activities in, or obstruct access to neighboring booths, or that impedes aisles, is prohibited. ***Distribution of any materials or performing of any other solicitations in the aisles or public areas is prohibited.*** Show Management, at its discretion, may take any action it deems appropriate (including, but not limited to **issuing written warnings**, the expulsion from the show, and/or suspension or elimination of NPE show history points) against an exhibitor for conduct detrimental to the show.

31. Hanging: Displays, Signs, Banners & Trusses

Hanging signs are permitted in the South and West exhibit halls **PROVIDED ALL GUIDELINES ARE FOLLOWED. NO VARIANCES WILL BE PERMITTED.** Hanging signs/grid work from the ceiling will be permitted but must comply with facility rules and regulations, as well as applicable show display rules and regulations. Show Management permits ceiling-hung corporate identification for exhibiting companies occupying 400 square feet or more in an island or split island space configuration.

Hanging signs, trusses, and graphics shall be set back 10' from adjacent booths and be directly over contracted space only.

The bottom of the sign must be a minimum of 18 feet from the ground and no more than 26 feet from the ground to the top of the sign. Overhead truss may exceed the 26' height limit. Mandatory 2' vertical distance - A 2' vertical distance must separate all hanging signs from all floor supported displays. The 2' vertical distance applies to the full footprint of the booth space, regardless of placement of banners and displays. A 2-foot vertical distance must separate the hanging sign from any structure. The 2' vertical distance does not apply to machinery in its original form.

Should the hanging sign be in violation or the wording on any sign be deemed by Show Management to be contrary in any way to the Principal Purpose, Exhibitor shall immediately make such changes requested by Show Management and assume responsibility for any expense incurred (also refer to [Rule 51, Signs](#)). Show Management reserves the right to deny any hanging structure onsite (truss or signage) if the hanging sign is in violation of said rules. It is imperative that all procedures be followed properly:

Ceiling Heights:

West Hall A, B, D:	40' to Beam
West Hall C:	33' to Beam
West Hall E:	30' to Beam
South/North Hall:	40' to Beam

- A. Show Management approval is **required** by **April 8, 2024**, for all hanging signs. Show Management requires Exhibitors submit the NPE2024 Booth Design Approval Form and design plans along with an elevation plan. The design plan should include relationship of sign to perimeter of booth, front elevation view showing sign height over booth to include truss. **NO VARIANCES WILL BE PERMITTED**
- B. OCCC Hanging Items Approval/Request Form (HM1) is due by **April 2, 2024** (please review Hanging Items requirements in the [OCCC section of the Exhibitor Dashboard](#)).

32. Hazardous & Prohibited Material

Exhibitors shall not bring upon the premises of the OCCC any exhibit, equipment, product, material, or vehicle that, in the judgment of Show Management or the OCCC, would be, or might be, dangerous to persons and/or property and/or otherwise incompatible with the structure, systems, and furnishings of the OCCC. Hazardous chemicals and materials, including, but not limited to, pesticides, herbicides, poisons, flammable and combustible liquids, hazardous gases, and chemicals (including oxidizers) are prohibited inside the OCCC.

Compressed inert gases may be used provided the vessels are stored in a safe manner. Demonstrations involving inert gases must comply with all federal and local regulations. Gasoline, kerosene, diesel fuel, combustible gases, or other flammable liquids may not be stored (permanently or temporarily) in the OCCC during the show or during move-in and move-out. Exhibitors will be responsible for removal of hazardous waste and must comply with all applicable federal, state, and local regulations. Hazardous waste includes materials that are ignitable, corrosive, reactive, toxic, or biohazards (as defined under 40 CFR 261 subpart C and D).

33. Indemnification

Exhibitor agrees to indemnify and hold harmless Show Management from and against any and all claims, losses, liabilities, actions, suits, demands, damages, costs, and expenses (including, without limitation, reasonable attorney's fees), made by anyone including but not limited to Exhibitor's employees (including Booth Personnel), NPE2024 attendees, and/or other Exhibitors arising out of or relating to any alleged personal and/or economic injury while attending or working at the show arising out of, caused or allegedly caused, by Exhibitor's machinery, exhibit and/or activities at Exhibitor's booth, any breach of these rules, and/or any alleged wrongful acts or negligence of Exhibitor or its agents or employees.

34. Installation & Dismantle Labor

Currently, Freeman has an agreement with the Local IATSE Union to provide labor for display installation and dismantling. **Full time employees of the exhibiting companies, however, may set their own exhibits without assistance from this local union.** Any labor services that may be required, beyond what your regular full-time employees can provide, must be rendered by the Union labor. Labor can be ordered in advance by returning the Freeman Display Labor form, as amended, or at show-site in the service center.

35. Insurance

Exhibitor shall, at its sole cost and expense, procure and maintain insurance as required by PLASTICS and subject to its NPE2024 Exhibitor Certificate of Insurance Guidelines, comprehensive general liability insurance against claims for bodily injury or death and property damage occurring in or upon or resulting from activities conducted on the premises leased by PLASTICS. Such insurance shall not contain a waiver of subrogation and shall include coverage for contractual liability, compensatory damages, and special, indirect, consequential, and punitive (where allowed by applicable law) damages with combined single limits of liability of not less than \$1,000,000 per occurrence and \$2,000,000 in aggregate. Such insurance shall name Plastics Industry Association (PLASTICS) and the Orange County Convention Center (OCCC) as additional insureds. Exhibitor agrees to provide Show Management acceptable evidence of insurance coverage meeting the required terms prior to delivering/shipping any equipment to the OCCC. All property of Exhibitor is understood to remain under its custody and control in transit to and from the confines of the exhibit hall and during the show. Show Management will not assume liability for any injury that may occur to show visitors, exhibitors, or their agents and employees, or others.

Exhibitor agrees to carry and provide proof of insurance to Show Management no later than **January 31, 2024**. Show Management reserves the right to withhold Exhibitor's booth personnel registration access, show badges, and/or other show services as it deems appropriate, if proof of insurance is not submitted by Exhibitor to Show Management by **January 31, 2024**.

36. International Shipments

Shipments initiating from outside the United States to the show may not reference, NPE, PLASTICS or Show Management as the consignor or recipient. Shipments must be consigned to the Exhibitor, C/O Freeman Decorating Company.

37. Limitation of Liability

Exhibitor agrees to make no claim for any reason whatsoever against PLASTICS, Orange County Convention Center, City of Orlando, and/or State of Florida, for loss, theft, damage, or destruction of goods; or for any injury to himself/herself or employees while in the exposition complex; or for any damage of any nature, including damage to their business by reason of failure to provide space for their exhibit; or for any action of any nature of PLASTICS, Orange County Convention, City of Orlando, and State of Florida, for failure to hold the show as scheduled, or any other claim as it relates to NPE2024.

38. Machinery, Robots & Equipment Placement

No height limitation (other than ceiling height limitations of the exposition halls) shall apply to machinery or equipment placed in position comparable to actual utilization for industrial purposes. All aisle space belongs to PLASTICS. Obstruction of aisles or booths is not permitted. No exhibit or advertising will be allowed to extend beyond the booth space assigned to the Exhibitor. All demonstration equipment to include machinery, machine **monitors/screens (HMI's)**, keypads, rotating extensions, demonstration, and operators' position must be located inside the rented booth space 1' / .304M from the aisle line. **TV monitors are exempt from the 1' / .304M set back rule.**

No portion of a machine, product or display piece may extend beyond the boundaries of the exhibitor's assigned exhibit space. All machinery and equipment must be set back at least 1' / .304M from all aisle ways for safety purposes.

Any demonstration or activity that results in excessive obstruction of aisles or prevents ready access to a nearby exhibitor's space shall be suspended for any period specified by show management.

39. Meeting Rooms at Orange County Convention Center (OCCC)

OCCC meeting rooms are very limited and are only available for rental to Exhibitors. Rental fees and additional charges (AV, catering, re-sets, etc.) associated with the use of meeting rooms is the responsibility of the Exhibitor and will be billed directly to Exhibitor by OCCC and/or other contractors utilized.

Meeting rooms may be rented pre-show, during show, and post-show based on availability. Meeting room assignments are made on a first-come, first-served basis. Meeting room utilization is for food functions, meetings, and staff offices only. Product displays, and hospitality events are prohibited during show operating hours. Violation of this policy will result in the immediate closure of the room and may result in the Exhibitor's loss of NPE show history points earned for NPE2024. Show Management will take into consideration the nature of the meeting and the overall benefit to the show in its assignment of meeting space.

40. Move-Out Material Removal from Premises

Exhibitor shall be liable for all storage and handling charges resulting from failure to remove exhibit material from OCCC before the conclusion of the dismantling period as specified by Show Management.

41. Music, Video, Photo & Copyrights

Exhibitors using music in their booth, either live or mechanical, must provide Show Management with a copy of the exhibitor's Licensing Agreement with ASCAP, BMI, SESA, or other such licensing organization or must expressly warrant in writing to Show Management that no such license is required due to exemption under 17 U.S.C. 110 (5) or other specified exemption. Show Management reserves the right to remove from the exhibit halls, at Exhibitor's expense, all or any part of any booth or display which incorporates copyrightable material for which Exhibitor fails to produce proof that Exhibitor holds all required licenses. Exhibitor shall remain liable for and shall indemnify, and hold Show Management, their agents, and employees, harmless from all loss, claims, causes of action, suits, damages, liability, expenses, and costs, including reasonable attorney's fees, arising from or out of any violation or infringement (or claimed violation or infringement) by Exhibitor and/or Exhibitor's agents.

42. Noise Levels

Exhibitors operating sound reproducing, or sound amplifying equipment are required to operate in such a manner that a maximum 85 dB reading on the "A" scale of a sound level meter may be read at the aisle(s) space adjacent to their booth or measured at a neighboring booth in an area bordering that of the sound equipment user. No noisy or obstructive work will be permitted during show hours, nor will noisily operating displays be allowed. Show Management shall be the sole arbiter of acceptability of sound levels and may require reduction of sound level or elimination of sound reproducing devices in those instances where in the judgment of Show Management such sound is in violation of these standards or otherwise objectionable.

Equipment or machinery producing excessive vibration of building components or exhibit, or excessive noise may be subject to limited or no operation if, in the judgment of Show Management, it interferes with neighboring exhibits or with the show. OSHA's Occupational Noise Exposure Standard, 29 C.F.R. 1910.95 establishes maximum permissible noise levels tied to the time of exposure. In addition to complying with that rule, Exhibitors operating equipment during the show must operate the equipment so that peak and/or continual noise levels do not interfere with other Exhibitors or the show. Generally, PLASTICS strives to maintain ambient noise at a level not to exceed 85 decibels and to minimize the magnitude and frequency of noise peaks that exceed that level.

43. NPE2024 Logos

Various versions and formats of the NPE2024 logo can be downloaded online at www.npe.org/logos. The logos are the property of PLASTICS and may not be used unless it is the intent of Exhibitor to use the logos for the sole purpose of promoting their participation in NPE2024 in appropriate form. The NPE2024 logos or any other trademark of PLASTICS or OCCC that Exhibitor has expressly been granted specific use shall not be altered, modified, or incorporated with any other words, logos, or symbols without the express written consent of PLASTICS. (Also refer to [Rule 16, Copyright, Patent & Trademark Infringements](#).)

44. Odors

No exhibit producing objectionable odors is permitted. Show Management reserves the right, in its sole discretion, to order the immediate removal of an exhibit that produces objectionable odors or to have such an exhibit removed at Exhibitor's expense.

45. Outdoor Exhibit Space

The outdoor exhibit space will be located in the North/South building parking lot of the Orange County Convention Center. As this space is outside, several additional requirements must be met, and rules will apply to companies participating in this offering.

Eligibility Requirements:

- Company must contract for and occupy a minimum of 2,000 net square feet of indoor exhibit space to be considered for outdoor exhibit space.
- Company must contract for a minimum of 2,000 net square feet of outdoor exhibit space in addition to the indoor exhibit space.

Additional Requirements:

- Company will be responsible for building, outfitting, and promoting attendance to its outdoor exhibit space.
- Company will be responsible for all costs involved, including but not limited to construction of outdoor building, utilities, climate control, booth furnishings and decorations, and promotion of booth and booth location to NPE2024 attendees.

Rules & Regulations:

All Rules & Regulations as outlined in the [NPE2024 Show Rules & Regulations](#) apply to and must be complied with for both indoor and outdoor exhibit spaces. Additionally, the following criteria must be met and will be enforced for outdoor exhibit space:

- A floorplan with utility requirements must be received and approved by Show Management and the Orange County Convention Center.
- No aerial rigging services will be provided from the OCCC.
- Due to environmental protection, there will be no water drains available. Each exhibitor will need to be self-contained.
- There will be no anchoring, staking, or drilling into the pavement. Securing of tents, machinery or display items require the use of ballasts. Any fees due to damages will be incurred by the exhibitor.
- Any propane needed will be provided through the OCCC.
- All machines/equipment with power requirements must be submitted and reviewed by Show Management and OCCC in advance to ensure the required power is available in the outdoor exhibit space.
- Exhibitors will not be able to fuel any equipment.

46. Plastics Industry Association (PLASTICS) Member Benefits for NPE2024

PLASTICS Members are entitled to NPE benefits including a discount on exhibit space rates and selection of exhibit space prior to non-member companies during the NPE2024 Space Draw. Exhibit space is assigned in order of PLASTICS members with the highest show history designation to PLASTICS members with the lowest show history designation, followed by non-members with the highest show history designation to non-members with the lowest show history designation. To be eligible for NPE benefits, PLASTICS members must maintain *continuous membership show to show in good standing for each show in which Company receives NPE member benefits*. In addition, Company agrees that all membership dues for 2022, 2023, and 2024 will be paid in full and in a timely manner by the membership payment due date(s) for eligibility to receive NPE member benefits for NPE2024.

PLASTICS membership renewal forms are released annually by November 15 and membership dues are to be paid in full by January 1 of the following year. Any Company that fails to submit their dues payment by January 1 will be considered as *pending membership suspension* and will no longer be considered a member in good standing. Management reserves the right to relocate a Company's space should their PLASTICS membership be terminated or suspended for non-payment of dues. Company agrees that the non-member exhibit space rate will be applied to its exhibit space fees should their PLASTICS membership be resigned, terminated, or suspended for non-payment of dues.

For membership information, please contact PLASTICS at +1.202.974.5212 or email membership@plasticsindustry.org.

47. Reduction of Space

Exhibitors requesting a reduction of exhibit space shall remain liable for the released square footage and shall pay to PLASTICS all space fees for the current square footage and the released square footage (see [Rule 11, Cancellation of Company Participation & Space Changes](#), for more information).

48. Rejected Displays

Exhibitor agrees that their exhibit shall be admitted and shall remain from day to day solely on strict compliance with the Show Rules and Regulations, policies, and guidelines. Show Management reserves the right to reject, eject, or prohibit any exhibit in whole, or in part, or Exhibitor or Exhibitor's Booth Personnel. If an Exhibitor or Exhibitor Booth Personnel is ejected for violation of these rules or for other stated reasons, Exhibitor shall be deemed to have cancelled its participation in the show and would be subject to the cancellation policy (see [Rule 11, Cancellation of Company Participation & Space Changes](#)).

49. Relocation of Booth

Relocation of exhibit space shall be accommodated based on availability as determined by Show Management. Once exhibit space is selected and/or assigned, an Exhibitor interested in relocating its exhibit space may submit a request to Show Management detailing their maximum and minimum square footage requirements and location preference(s). Available exhibit space fulfilling requirements of Exhibitors on the booth relocation list will be offered to those Exhibitors based on their NPE show history designation status (Members with highest show history to lowest prior to Non-Members with highest show history to lowest). If the exhibit space is not taken after being offered to Exhibitors on the booth relocation list, the exhibit space will be assigned to new exhibitors on a first-come, first-served basis. Exhibitors that relocate to larger space will be financially obligated for the total space fees applicable to the new total square footage. Exhibitors that relocate to reduced space remain financially obligated for the full payment of the original contracted/assigned space.

50. Safety: Machinery, Robot & Exhibit

Exhibitor is solely responsible for compliance with national, state, and local laws and regulations in the provision and maintenance of adequate safety devices and conditions for the installation and operation of machinery and equipment displays.

Robots mounted to any piece of plastic processing equipment shall reference the appropriate ANSI/PLASTICS B151 standard in regard to guarding/safeguarding of said robot when mounted to the specific type of machinery referenced in the appropriate ANSI/PLASTICS B151 standard. If the robot is not mounted to a piece of plastic processing equipment, then the robot shall be guarded/safeguarded per ANSI/RIA 15.06.

Robots must be classified as "collaborative" if they are to be displayed without risk reduction measures (safeguarding) as discussed above. Collaborative operations may include one or more of the following methods (described in more detail below), any of which are permissible for exhibitors to use:

- safety-rated monitored stop;
- hand guiding;
- speed and separation monitoring; and/or
- power and force limiting.

Robots designed for collaborative operation shall provide a visual indication when the robot is in collaborative operation and shall comply with one or more of the requirements listed in ISO 10218-1 section 5.10.2 to 5.10.5. The power and force limiting function of the robot shall be in compliance with ISO 10218-1 section 5.4. If any parameter limit is exceeded, a protective stop shall be issued. For questions regarding collaborative robots refer to ISO/TS 15066 which contains valuable guidance on risk assessment for the integration of collaborative robots.

Special caution should be taken when demonstrating machinery or equipment that has moving parts or any product that is otherwise potentially dangerous. Machinery and other large equipment must be set back 1' / .304M from the aisle line to prevent accidental injury. Demonstrations should only be conducted by qualified personnel.

No portion of a machine, product or display piece may extend beyond the boundaries of the exhibitor's assigned exhibit space. All machinery and or equipment must be set back at least 1' / .304M from all aisle ways for safety purposes.

Any demonstration or activity that results in excessive obstruction of aisles or prevents ready access to a nearby exhibitor's space shall be suspended for any period specified by show management.

All displays, exhibit materials and equipment must be reasonably located and protected by safety guards and fireproofing to prevent fire hazards and accidents. Adequate fencing and/or shielding of all operating machinery displays shall be installed to prevent attendees from coming into contact with the operating machinery and/or its movement by reaching over, under or around such protection.

Example:

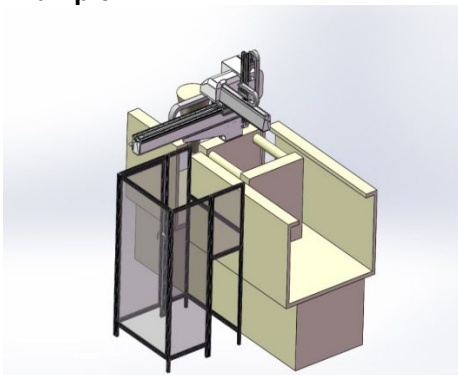

Exhibitor agrees to notify Show Management of its intent to use **Hydraulic Oil**. Hydraulic Oil is permissible provided Show Management is notified by **April 2, 2024**, of the quantity and anticipated delivery date to the exhibit floor based on the scheduled move in/out dates provided by Show Management. Exhibitors are not permitted to place containers of Hydraulic Oil in the aisles during installation or dismantling periods of the show. The aisles must be kept clear for the specific use of material handling trucks and equipment and the safety of others.

Exhibitor agrees that its exhibit shall meet and remain in compliance with the safety requirements specified. Show Management reserves the right to reject, eject, prohibit, or cease operation of any exhibit in whole or in part for non-compliance with safety requirements. Management does not assume liability for any injury that may occur to show visitors, exhibitors or their agents and employees, or others. Exhibitor agrees to carry and provide proof of insurance to Management by **January 31, 2024**. Management reserves the right to hold Exhibitor's booth personnel registration, show badges, exhibit freight, refuse the installation of utilities, etc., if proof of insurance is not submitted by Exhibitor.

51. Signs

Signs involving the use of Neon or similar gases are prohibited. Exhibitor may not place signs promoting another company's name in their booth or on machinery in their booth, except where such signs are required for the proper demonstration or operation of Exhibitor's display, in which case identification of such articles shall be limited to the nameplate, imprint, or other identification which in standard practice normally appears on them. Should the wording on any sign be deemed by Show Management, in its sole discretion to be contrary in any way to the Principal Purpose, Exhibitor shall, at Show Management's request and at its own expense, immediately remove said sign or make such changes as are requested. If Exhibitor refuses Show Management's request, Show Management reserves the right to remove the sign at Exhibitor's expense. Management approval is required by **April 8, 2024** for all hanging signs and requires Exhibitor submission of the NPE2024 Booth Design Approval Form and design plans. Also see [Rule 31, Hanging: Displays, Signs, Banners & Trusses](#).

52. Solicitation, Costumes & Promotion

Exhibitor Booth Personnel may conduct discussions, answer questions, explain Exhibitor's products or services, or engage in sales solicitation or order taking, but such activities shall not be conducted in any manner which is inconsistent with, or derogates from, the Principal Purpose. Exhibitor shall cease any activity determined to be inconsistent with the Principal Purpose immediately upon notification by Show Management to do so. Exhibitor Booth Personnel wearing distinctive costumes or carrying banners or signs separately or as part of their apparel must remain in their own Exhibitor booth.

Distribution of any materials or performing of any other solicitations in the aisles or public areas is prohibited. Show Management, at its discretion, may take any action it deems appropriate (including, but not limited to **issuing written warnings**, the expulsion from a show, and/or suspension or elimination of NPE show history points) against an exhibitor for conduct detrimental to the show.

Selling is permitted on the exhibit floor provided Exhibitor abides by Florida state laws, is solely responsible for collection and remittance of all applicable sales or other taxes and conducts business in a professional manner. However, Exhibitor may not exhibit, offer for sale, give as premium, or advertise articles not manufactured or sold in Exhibitor's name, except where such articles are required for proper demonstration or operation of Exhibitor's display, in which case identification shall be limited to the nameplate, imprint, or other identification which in standard practice appears normally on them.

53. Storage

Exhibitors may keep a one-day supply of literature in their booths but cannot store empty cartons in or behind booths. Freeman will temporarily remove your empty skids, crates, cartons, containers (including plastic), and packaging materials labeled with stickers marked empty. These empty containers will be returned to you during the dismantling period. Arrangements for storage and delivery of materials can be made through Freeman.

54. Subleasing

Company may not sublet its space, nor any part thereof, nor exhibit, offer for sale, give as premium, or advertise articles not manufactured or sold in its Company's name, except where such articles are required for proper demonstration or operation of Company's display, in which case identification shall be limited to the nameplate, imprint, or other identification which, in standard practice, appears normally on them. Company may not permit non-exhibiting company representatives to occupy or sell non-exhibiting company services or products in its booth. Rulings of Management shall, in all instances, be final with regard to use of exhibit space.

55. Target Dates

Move-in (inbound) target dates will be assigned to each Exhibitor by Freeman. If you have any questions or concerns regarding your assigned target dates, please contact Freeman immediately. All shipments must arrive on the assigned target date and time for check-in at the Freeman Marshaling Yard. Off-target freight will incur an additional charge over and above the NPE Bundle Package pricing.

56. Trusses

If you plan to install trusses over your booth, (see [Rule 31, Hanging: Displays, Signs, Banners & Trusses](#)). Show Management approval is required by **April 8, 2024**, for all hanging signs and requires Exhibitor submission of the NPE2024 Booth Design Approval Form and design plans.

57. Unoccupied Space

Show Management reserves the right to use any exhibit space unoccupied at 4:00 p.m. Eastern Time on Sunday, May 5, 2024.

58. Utility Package Pricing

PLASTICS and OCCC have worked diligently to create an inclusive utility services package to assist Exhibitors in projecting budgets and controlling expenses. **A utility fee of \$1.33 per square foot will be assessed to all Exhibitors which includes unlimited service and labor for 120V electrical power.**

➤ What Is Included When I Order a Utility Package?

- When you pay for any of the utility packages offered by the OCCC, the following is included:
 - **An unlimited number of items in that package.** For example, if you pay for the 208V-480V Electrical Service Package, you can order as many 208V-480V outlets as you need for your booth.
 - Please keep in mind to expedite the placement of your order, while also keeping safety in mind, it is best to order the amount of power your equipment requires not the maximum that you can order.
- **Labor and placement.** Exhibitors will not be charged additional labor if your finalized booth diagram is received by **April 2, 2024.**
- **Taxes.** The package price includes all applicable local, state, and federal taxes.

(Refer to the [OCCC – Exhibitor & Utility Ordering Guide](#) section of the Exhibitor Dashboard for complete information and order forms).

59. Vehicle Displays

Motorized vehicles within the exhibit halls are permissible, provided that each vehicle can be defined as a vehicle that is propelled by an internal combustion engine using a Class I or Class II fuel, such as, but not limited to automobiles, trucks, motorcycles, aircraft, watercraft, and lawnmowers.

When placing motorized vehicles inside any area of the OCCC, occupancy levels must be considered regarding exits and exit access, so that these areas remain free of any obstructions, thereby ensuring a clear path for emergency egress. Vehicles must be positioned prior to the opening of the NPE2024 exposition on Sunday, May 5, 2024, 4:00 p.m.

Each vehicle will be subject to inspection for compliance with the following items: 1) all fuel tank openings shall be locked and sealed to prevent escape of vapors. Fuel tanks may not contain more than one-half capacity or ten (10) gallons of fuel whichever is less; 2) At least one battery cable must be removed from the batteries used to start the vehicle engine. The disconnected battery cable must be taped; 3) Batteries used to power auxiliary equipment are permitted to be kept in service; 4) Fueling or de-fueling of vehicles within the OCCC is prohibited; 5) Vehicles may not be moved during official show hours; and 6) Vehicles that will be running during show hours must be approved prior to the show by the OCCC Fire Marshal.

Vehicles, boats, and similar exhibited products with over 100 square feet of covered area must be protected with a listed smoke alarm.

60. Videotaping & Photography

No photograph or video of a booth, equipment and/or display material will be permitted without the express permission of Exhibitor. Should an Exhibitor object to its display being photographed (still or in motion), photographs/videos of that display will be prohibited. Show Management has appointed Official Photographers to provide commercial photographs of exhibits. No other commercial photographer/videographer will be admitted to the exhibits without the approval of Show Management and unless special arrangements are made as required by Show Management, including, but not limited to, hiring approved security to escort such photographer while inside the exhibition halls. Please refer to the Security Guard Order Form in the NPE2024 Exhibitor Dashboard.

Anyone found to be taking unauthorized photography (still or in motion) within the exhibit halls and/or registration areas, will be ejected from the show and have their photography equipment confiscated. If the violator of this policy is an Exhibitor, Show Management reserves the right to remove the exhibit and Exhibitor from the show at the Exhibitor's expense.

61. Walls & Backgrounds

Exhibitors building background or side dividers for their displays ascertain that the surfaces of such dividers are finished in a manner as not to be unsightly. If any surfaces remain unfinished or in any way in violation of other display rules, Show Management shall authorize the official decorator to affect the necessary finishing, and the Exhibitor in violation agrees to pay all related expenses. This regulation also applies to curved displays whether they are constructed of cloth or wire. Exhibitors must order drape or provide some other display component(s) to conceal wires or other unsightly materials behind curved displays.

62. Guidelines for Display and Column Specifications

The following guidelines for display rules and regulations have been established by the International Association of Exhibitions and Events (IAEE). The Guidelines are created to promote continuity and consistency among exhibitors. It is PLASTICS's goal that the display rules and regulations shall provide exhibitors with all the information necessary to properly design and build exhibits as well as plan their booth's layout and content.

Linear Booth - Constructed of Drape

Linear Booths, also called “in-line” booths, are generally arranged in a straight line, and have neighboring exhibitors on their immediate right and left, leaving only one side exposed to the aisle. **These booths are NOT constructed of hard wall. These are cloth/drape booths.**

Dimensions

Linear Booths are 10ft (3.05m) wide and 10ft (3.05m) deep, i.e., 10ft by 10ft (3.05m by 3.05m). **A maximum back wall height limitation of 8ft (2.44m) is permitted for display material.**

Use of Space

Regardless of the number of Linear Booths utilized, e.g., 10ft by 20ft (3.05m by 6.10m), 10ft by 30ft (3.05m by 9.14m), 10ft by 40ft (3.05m by 12.19m), etc. display materials should be arranged in such a manner so as not to obstruct sight lines of neighboring exhibitors.

The **maximum height of 8ft (2.44m)** is permitted only in the rear half of the booth space, with a **4ft (1.22m) height restriction imposed on all materials in the remaining space forward to the aisle.** **Note:** When three or more Linear Booths are used in combination as a single exhibit space, the 4ft (1.22m) height limitation is applied only to that portion of exhibit space which is within 10ft (3.05m) of an adjoining booth.

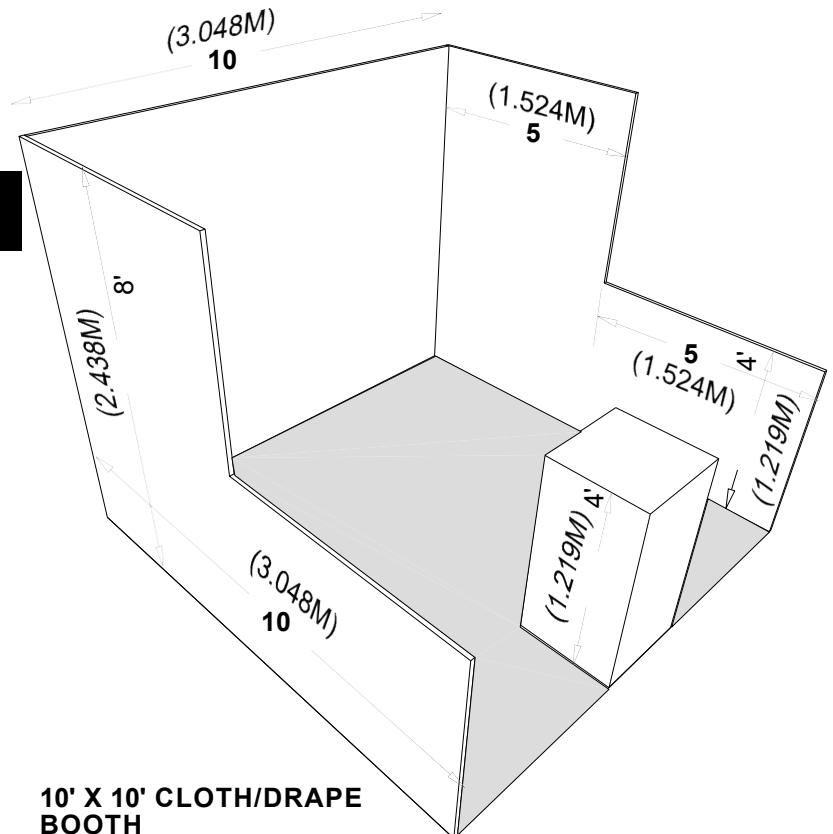
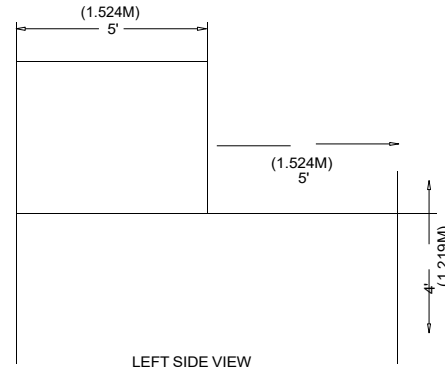
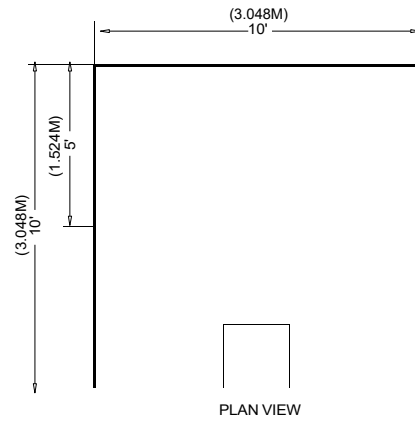

Corner Booth

A Corner Booth is a Linear Booth at the end of a series of in-line booths with exposure to intersecting aisles on two sides. All other guidelines for Linear Booths apply.

Perimeter Booth

A Perimeter Booth is a Linear Booth that backs to an outside wall of the exhibit facility rather than to another exhibit. **These booths are NOT constructed of hard wall. These are cloth/drape booths.**

Dimensions and Use of Space

All guidelines for Linear Booths apply to Perimeter Booths. **The maximum back wall height permitted is 12ft (2.44m) where facility allows.**

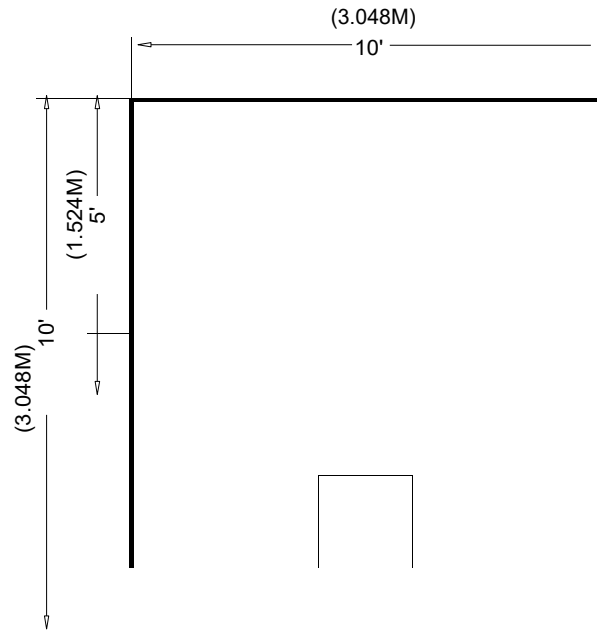

PLAN VIEW

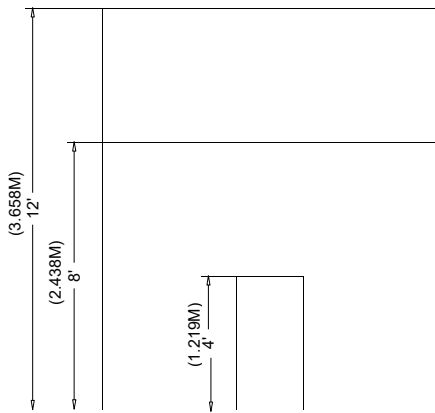

FRONT VIEW

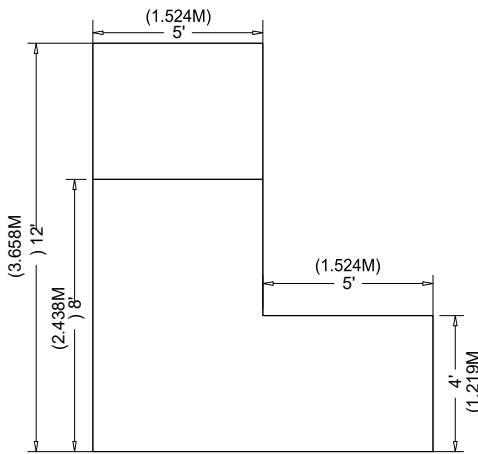

LEFT SIDE VIEW

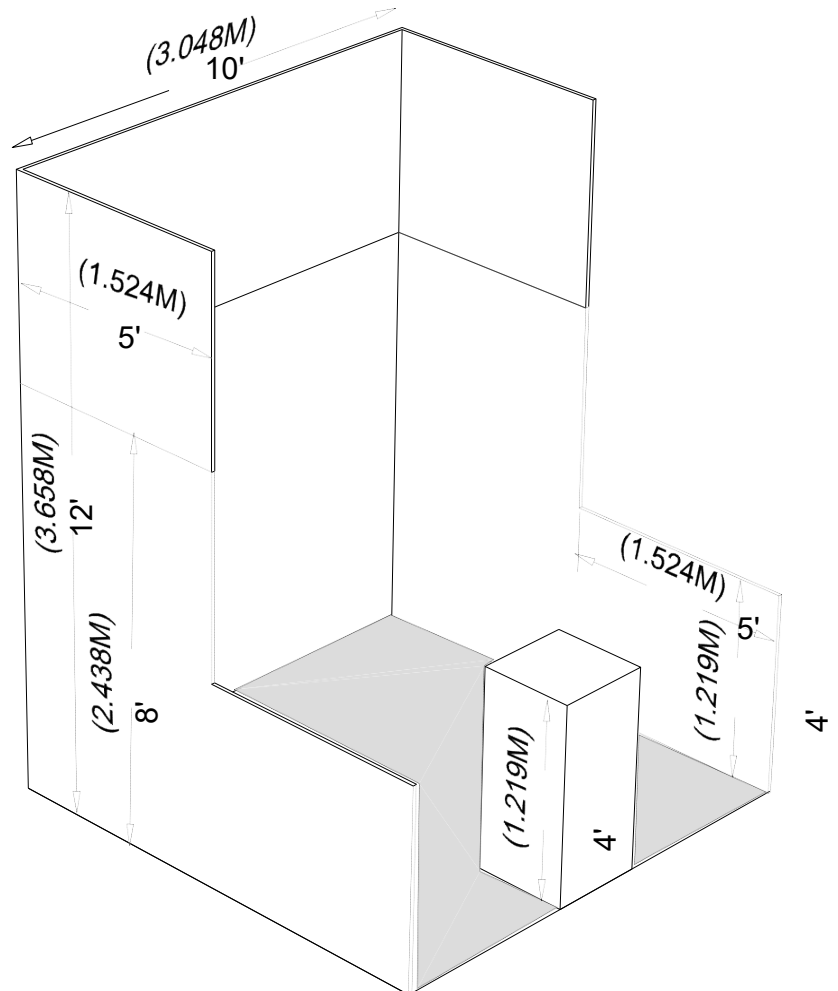

10' X 10' CLOTH/DRAPE PERIMETER BOOTH

Split Island Booth

A Split Island Booth is a booth exposed to aisles on three sides which shares a common back wall with another Split Island Booth.

Dimensions

A Split Island Booth is 20ft by 20ft (6.10m by 6.10m) or larger, although it may be configured differently.

The back of the common wall must be finished and cannot display any graphics of company logos.

The back wall is restricted to 4ft (1.22m) high within 5ft (1.52m) of each aisle, permitting adequate line of sight for the adjoining Booth. A maximum height allowance is 16ft (4.88m), excluding hanging signage. **Refer to Hanging Sign Rule 31. The entire cubic content of the space may be used up to the maximum allowable height for the display except for the mandatory 5'x10' corner set back.** Double-sided signs, logos and graphics shall be set back ten feet (10') (3.05m) from adjacent booths. **Refer to Machinery, Robots & Equipment Placement Rule 38.**

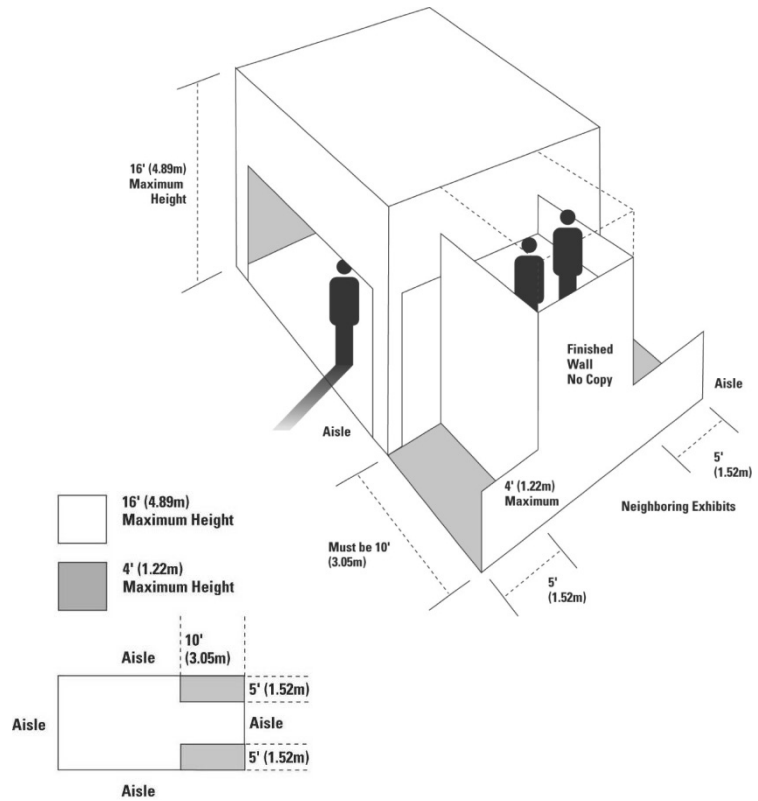

SPLIT ISLAND BOOTH

Island Booth

An Island Booth is any size booth exposed to aisles on all four sides.

Dimensions

An Island Booth is 20ft by 20ft (6.10m by 6.10m) or larger, although it may be configured differently.

Use of Space

The entire cubic content of the space may be used up to the maximum allowable height of 20', (6.10m), display and signage. Excluding hanging signage refer to **Hanging: Displays, Signs, Banners & Trusses Rule 31** and refer to **Machinery, Robots & Equipment Placement Rule 38**.

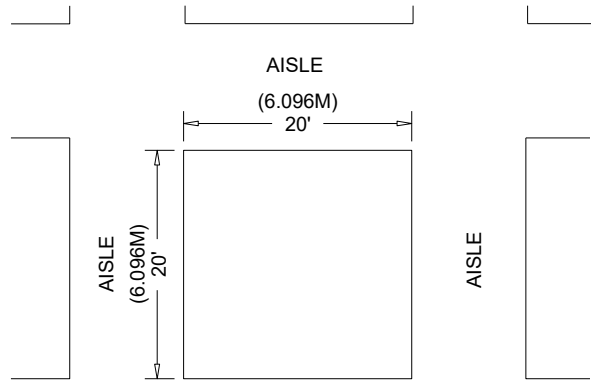

FRONT VIEW

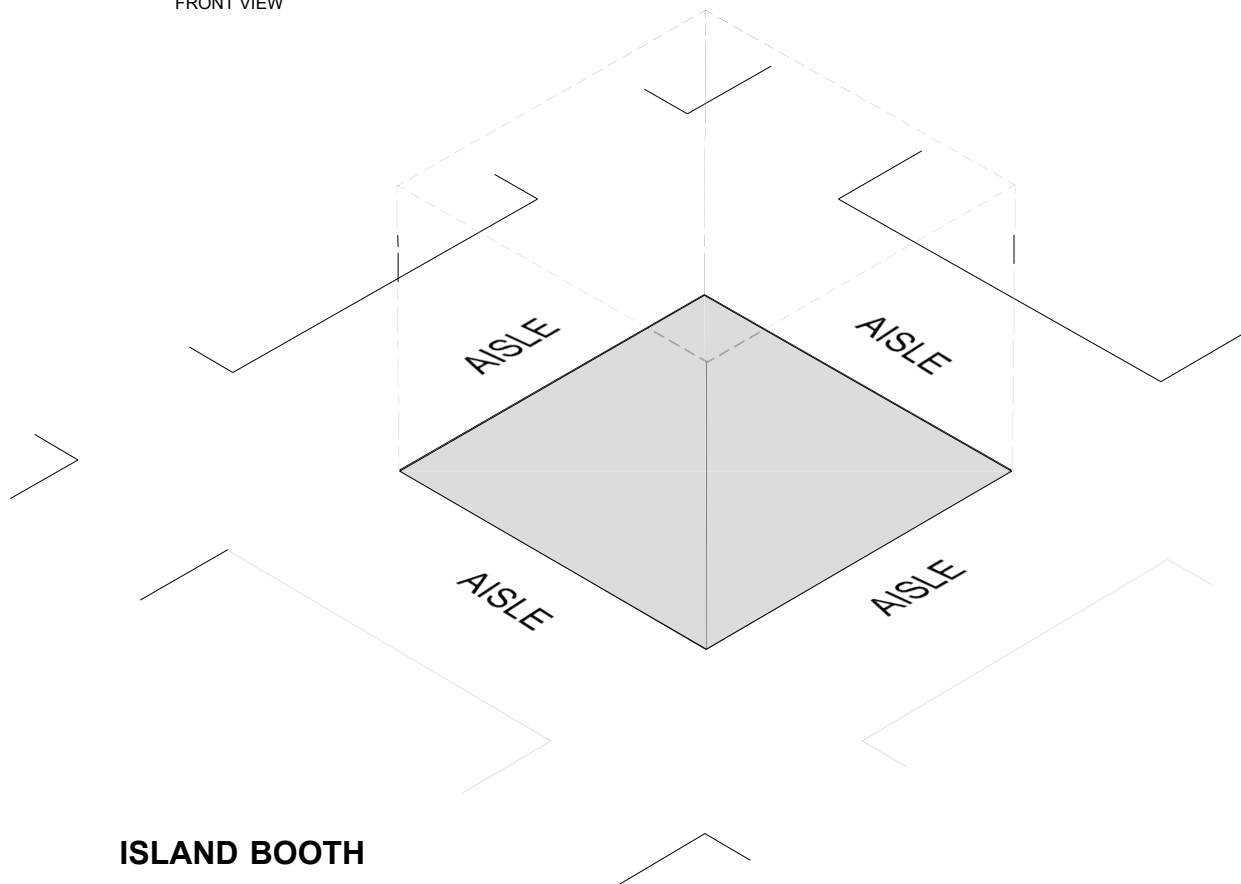

Extended Header Draped Booth 20ft (6.10m) or Longer

An Extended Header Booth is a Linear Booth 20ft (6.10m) or longer with a center extended header.

Dimensions and Use of Space

All guidelines for Linear Booths apply to Extended Header Booths, except that the center extended header has a maximum height of 8ft (2.44m), a maximum width of 20 percent of the length of the booth, and a maximum depth of 9ft (2.7m) from the back wall.

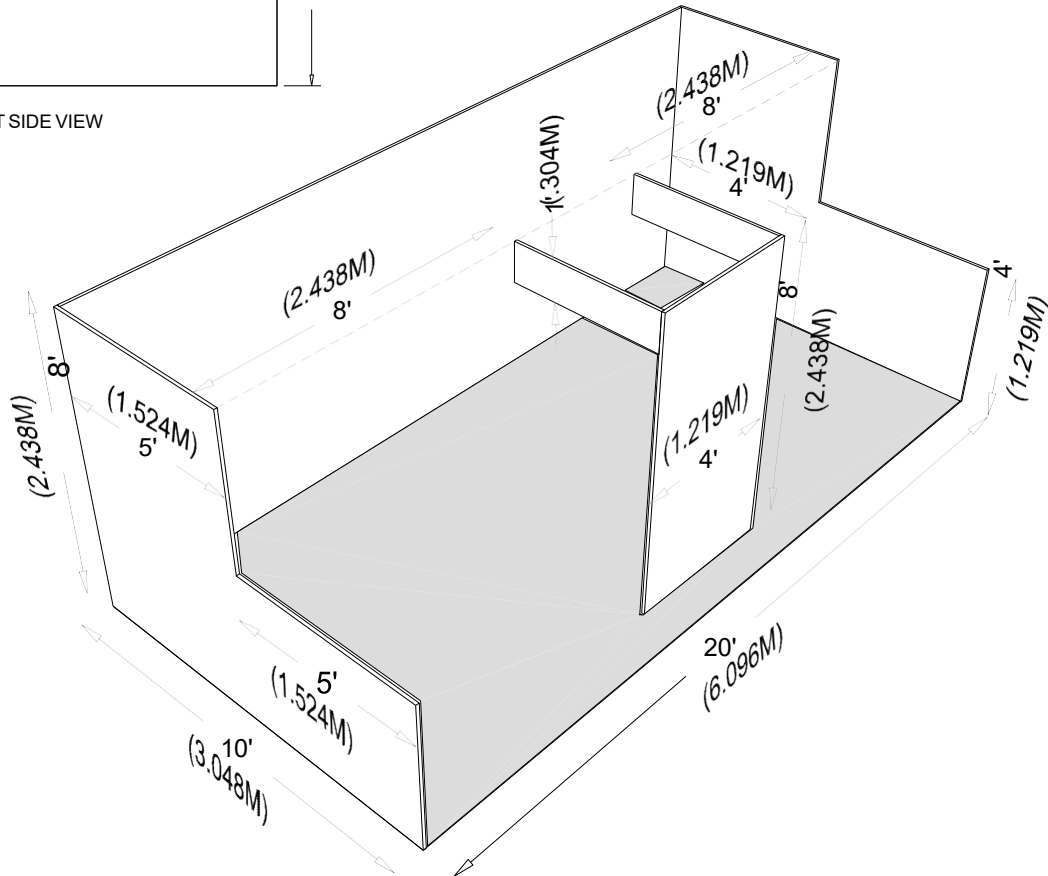
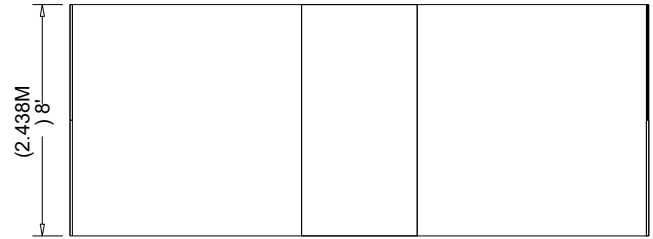
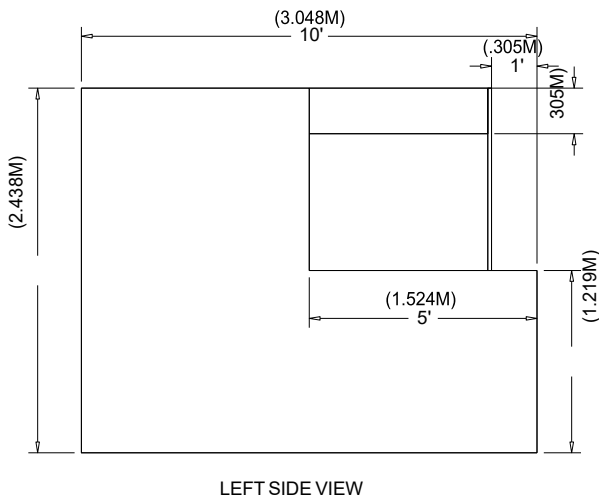
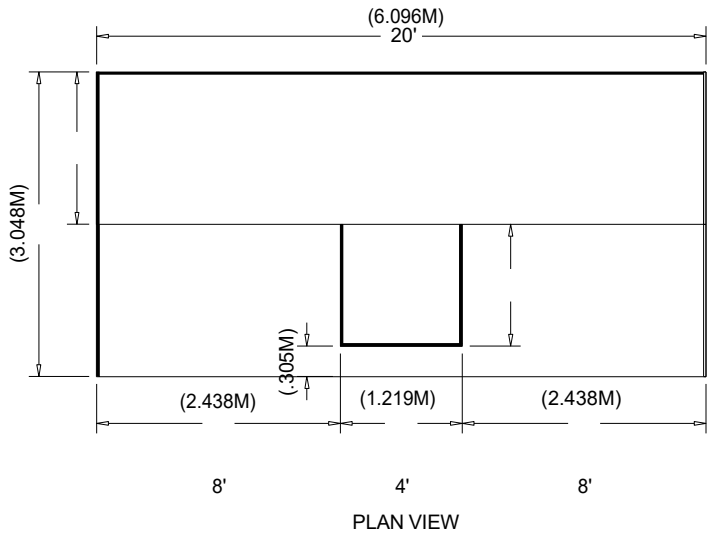

10' X 20' CLOTH/DRAPE PERIMETER BOOTH

Other Important Considerations

Canopies and Ceilings

Canopies, including ceilings, umbrellas, and canopy frames, can be either decorative or functional (such as to shade computer monitors from ambient light or to allow for hanging products). Canopies for Linear or Perimeter Booths should comply with Line-of-Sight requirements. (See “Use of Space” for Linear, Perimeter, and/or Extended Header Booths).

The bottom of the canopy should not be lower than 7ft (2.13m) from the floor within 5ft (1.52m) of any aisle. Canopy supports should be no wider than three inches 3in (.08m). This applies to any booth configuration that has a sight line restriction, such as a Linear Booth. Fire and safety regulations in many facilities strictly govern the use of canopies, ceilings, and other similar coverings. Check with the appropriate local agencies prior to determining specific exhibition rules.

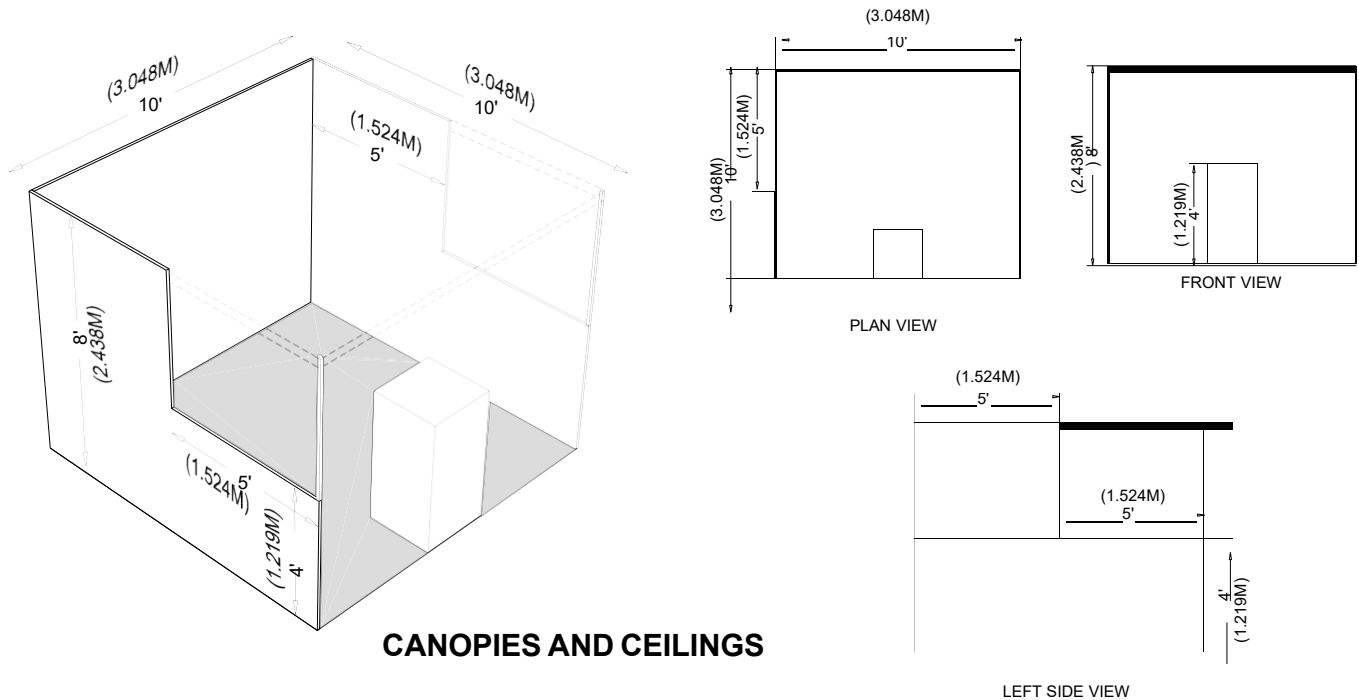

Multi-Level & Covered Booth

Covered Booth Definition: To place something over or upon an exhibit or portion of an exhibit (e.g., roof, ceiling, tenting, lattice, fabric, plastic) to cover the ground level and/or support decorative structures. The upper portion of a “covered” exhibit is not occupiable.

Multi-Level Booth Definition: To construct a level or tier atop an exhibit or portion of an exhibit, to be occupied by one (1) or more persons.

A. Guidelines for Covered Exhibits with Less Than Three Hundred (300) Covered Square Feet.

- 1) All materials used in the construction of covered exhibits and all decorative materials within the exhibit must be noncombustible or limited combustible (flame-retardant) materials. Certification of flame-retardant treatment, along with samples of said materials, must be submitted if requested by the Orange County Fire Rescue Services Department. It is recommended certifications of flame-retardant treatments be available at show site. Exhibitor must install a single station and battery-operated smoke detector on the interior of each covered exhibit or structure regardless of the square footage. The detector must sound an audible alarm and be installed per the manufacturer’s instructions.
- 2) Exhibitor must provide at least one (1) 2-A, 10-BC portable, dry chemical fire extinguisher. Fire extinguisher(s) must always be mounted in a visible location and be accessible.

- B. Guidelines for Multi-level Exhibits (regardless the size) and Covered Exhibits with Larger Than Three Hundred (300) Covered Square Feet. Requests for construction of multi-level (regardless the size) or covered exhibits (larger than 300 square feet) must be reviewed by the OCCC Event Management department and the Orange County Fire Rescue Services Department. To ensure success of your exhibit, please read and comply with the following guidelines:
- 1) Plans should be submitted before exhibit construction begins and must adhere to the following:
 - a. They must be scaled, signed, and dated by a registered architect or engineer.
 - b. They must include the show name and dates.
 - c. They must include exhibitor's name and assigned booth number. They must include directional information (i.e., indicate neighboring aisles and/or booth numbers).
 - d. They must indicate maximum exhibit height, within the booth. Height guidelines are established, per event, by Show Management.
 - 2) Send two (2) copies of scaled, signed, and dated blueprints (with front and side elevations), by a registered architect or engineer, to: **Orange County Convention Center, Attn: Event Management**
Regular Mail: PO Box 691509, Orlando, FL 32869
Overnight: 9860 Universal Boulevard, Orlando, FL 32819
 - 3) All materials used in the construction of multi-level and/or covered exhibits and all decorative materials within the exhibit must be non-combustible or limited combustible (flame-retardant) materials. If requested, certification of flame-retardant treatment, along with samples of said materials, must be submitted to the Orange County Fire Rescue Services Department. It is recommended certifications of flame-retardant treatments be available at show site.
 - 4) The upper deck of multi-level exhibits, if larger than three hundred (300) square feet, shall meet the following requirements:
 - a. Upper level may not have a "cover" of any kind (e.g., roof, ceiling, tenting, lattice, fabric, and plastic).
 - b. Exhibits with an enclosed room or occupied second story must post notice at the bottom of the stairway, indicating maximum permitted occupancy (or total permitted weight load of the second level).
 - c. If second level is to be occupied and greater than three hundred (300) square feet, two (2) stairways are required, remote from each other. If second level is to be occupied and less than three hundred (300) square feet, one (1) set of stairs is permitted. All stairs must be a minimum of three feet (3') in width, equipped with a handrail on at least one (1) side and constitute a "straight run" or be "squared off." Spiral stairs or winders are not permitted.
 - d. Individual areas of upper decks or covered areas must be limited to dimensions that do not exceed one thousand (1,000) square feet.
 - e. If the upper deck, or covered area, is greater than one thousand (1,000) square feet, a clear fire break (unobstructed aisle), of not less than ten feet (10') must be provided on all four (4) sides of each one thousand (1,000) square foot area. To avoid transfer of fire to another area, the firebreak (unobstructed aisle) shall not contain displays, furniture, or other materials.
 - f. The ten foot (10') clear space may be spanned by an overhead bridge or canopy which must not exceed four feet (4') in width. The bridge or canopy must be constructed of non-combustible materials.
 - g. Exhibitor must install a single station and battery-operated smoke detector on the interior of each covered exhibit or structure regardless of the square footage. The detector must sound an audible alarm and be installed per manufacturer's instructions
 - h. Exhibitor must provide a portable, dry chemical fire extinguisher for each level or each covered exhibit or structure. At least one (1) 2-A, 10-BC portable type fire extinguisher must be provided for each three hundred (300) square feet. Fire extinguishers must be mounted in a visible location, near exit doors, and always accessible.

Signs, Trusses, and Height Limitations – Split Island and Island Booths Only

1. All overhead signs maybe installed to a maximum of 26'.
2. Split islands and island displays may be displayed to a maximin of 20'
3. All overhead trusses may be installed above the height limit of 26'.
4. A 2' vertical opening is mandatory from the top of the ground supported structure to the bottom of all overhead structures. This 2' vertical opening applies to the entire booth footprint.
5. Individual spotlights may be installed overhead above the 26' limit with special permission.